

Synchronization Testing – an MEF Perspective

European Advanced Networking Test Center

Jambi I. Ganbar

November 5, 2009

Agenda

- **MEF Plans for Synchronization support in Carrier Ethernet**
- **Synchronization Testing at recent EANTC Interoperability Events**
 - IEEE 1588-2008
 - Synchronous Ethernet

MEF Synchronization Plans

MEF is advocating Ethernet as backhaul

Synchronization –
Integral to mobile
backhaul

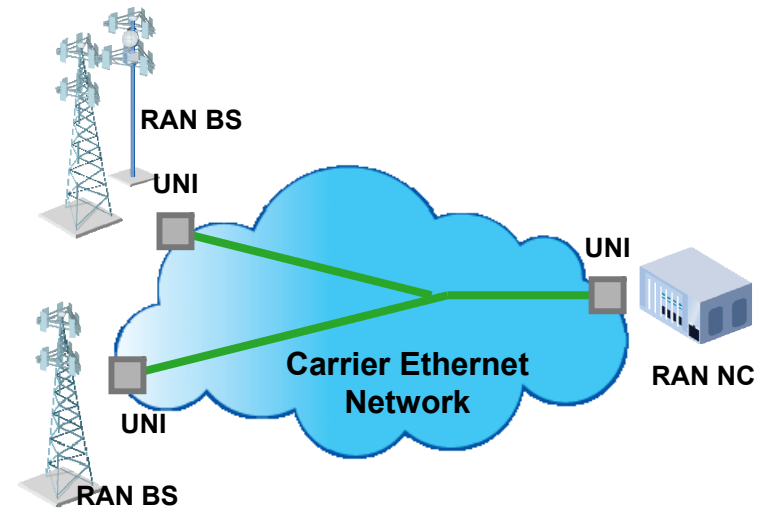

Packet/Frame Synchronization wider in
scope (examples):

- Transport applications
- Financial sector

MEF Approach to Synchronization

MEF22 – Mobile Backhaul IA – Current Specification

Packet based

- Synchronization quality requirements reference the ITU G.8261 standard
- Agnostic to specific methods/implementations like adaptive clocking, IEEE1588 etc.
- Eliminates the cost and need for retention of T1/E1 circuit solely for synchronization

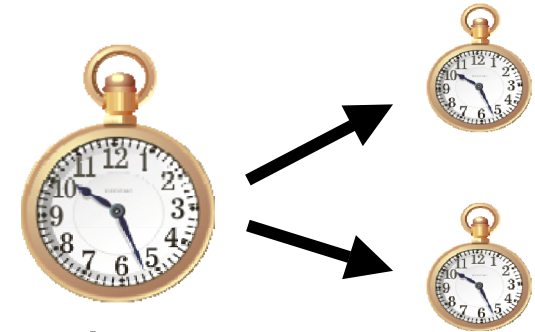

- **Other approaches**

- Common Clock (GPS, legacy E1 clocking) is out of scope
- Synchronous Ethernet in scope for future phases (phase 2)

Future MEF Synchronization Plans

Mobile Backhaul Implementation Agreement – Phase 2

Phase 2 work started spring 2009

– Planned completion - 2011

- +Synchronous Ethernet
- + specific Phase, Frequency and Time of Day requirements mapped to mobile standards
- Must work equally well across Microwave, Copper, and Fiber

PSN Synchronization Tested at EANTC

“Promote interoperability and deployment of Carrier Ethernet worldwide”

- 1588 Precision Time Protocol version 2 (PTPv2)
- Synchronous Ethernet
 - Ethernet Synchronization Messaging Channel (ESMC)



PTPv2 Results

Protocol
Interoperability and
Clock Quality
verification

ITU-T G.8261
Test case 12

- Impairment profiles from test case
- 1 hour MTIE measurements, compared ITU-T masks

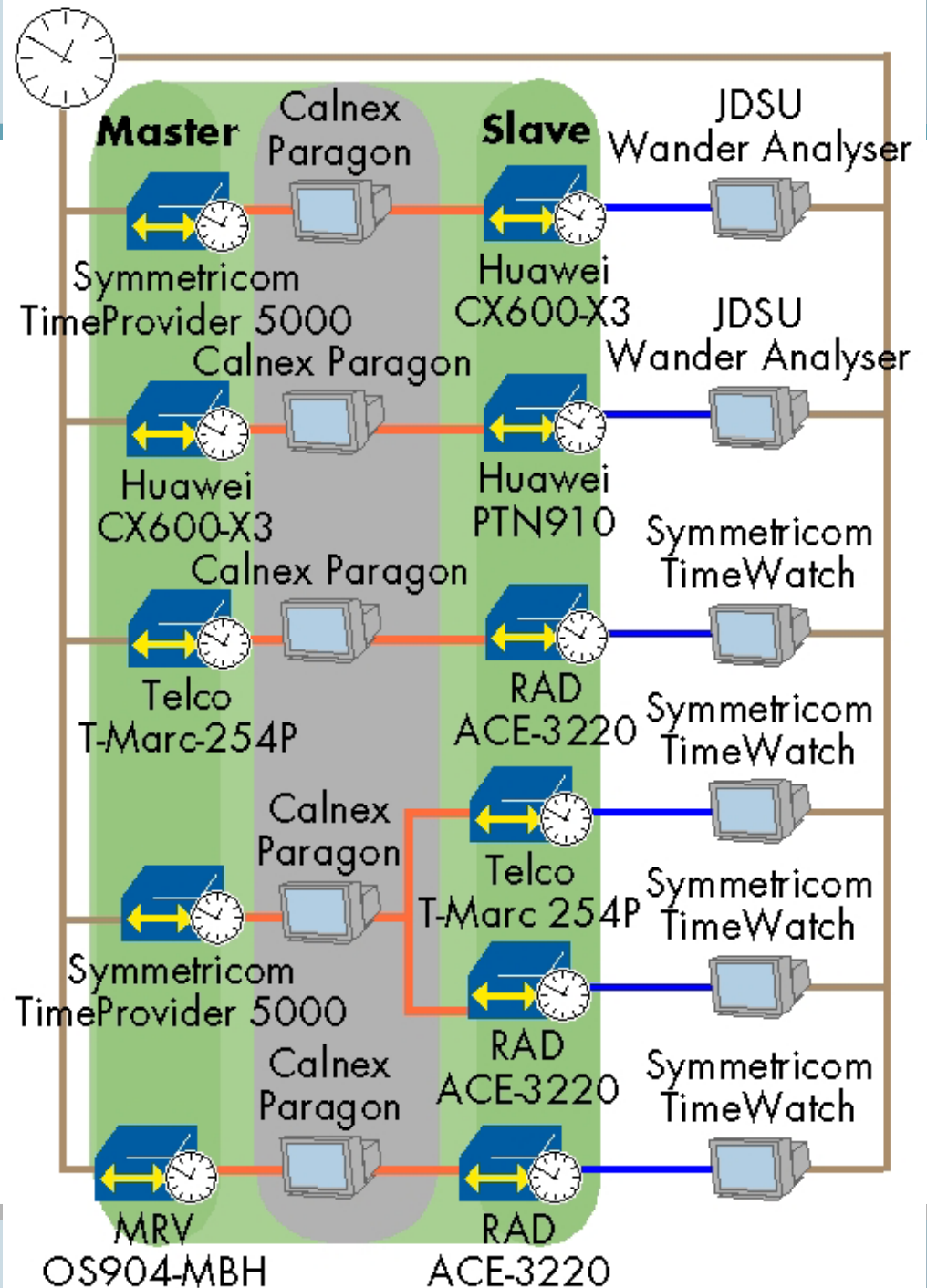

Symmetricom TimeMonitor Analyzer

MTIE; Fo=2.048 MHz; Fs=1.000 Hz; 2009/08/31 15:44:58

TimeWatch Phase; Samples: 14097; Start: 35904; Stop: 50000; DataSource=Symmetricom TimeWatch Probe

Edition=Standard; MeasurementType=2Mbps; ReferenceType=2MHz; SerialNumber=sw100301; SampleSpacing=1

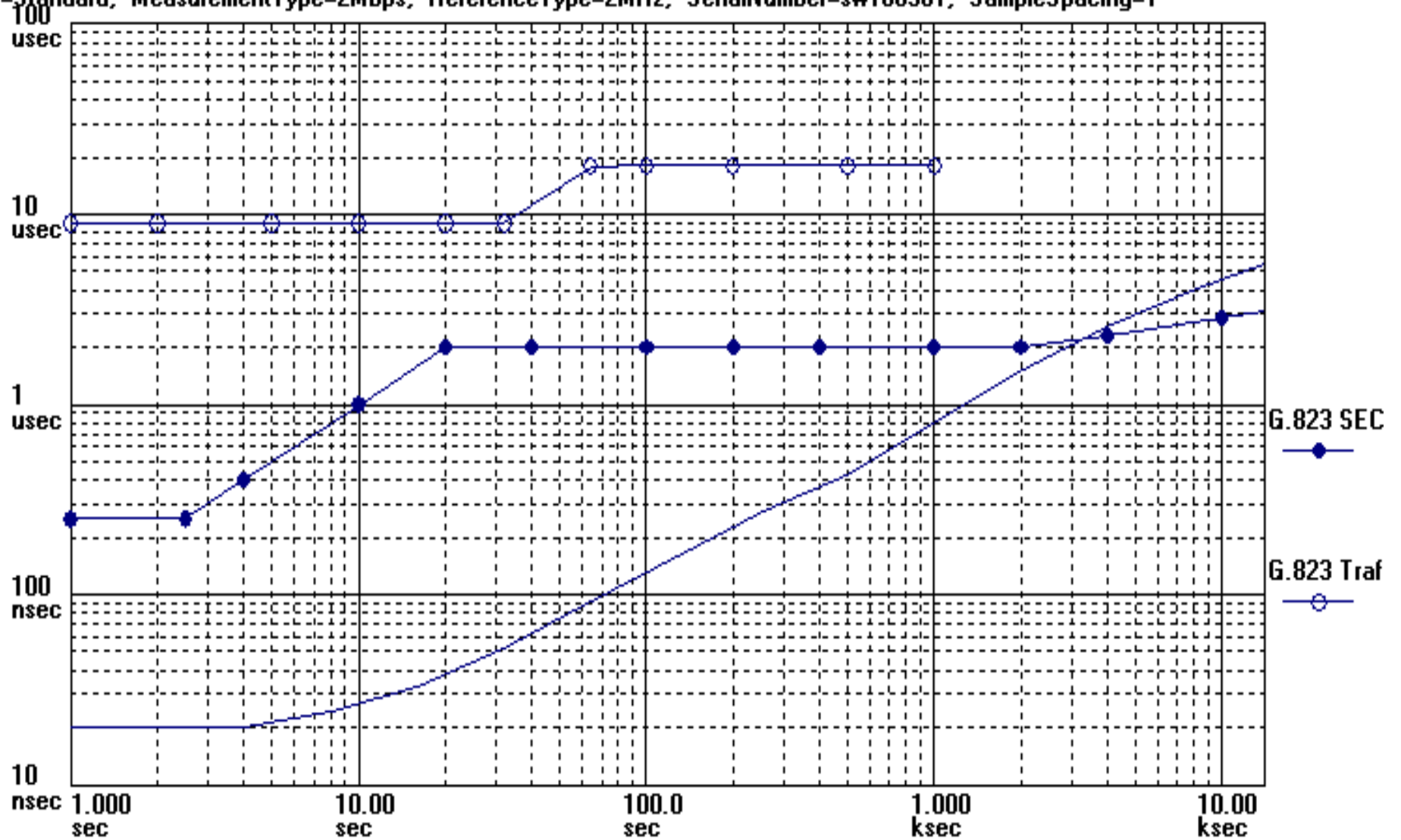

Example PTPv2 Result

Synchronous Ethernet Results

- 21 pairs tested
- Used ITU-T G.813 SEC Option 1 MTIE and TDEV masks
- 10-15 minutes measurements duration

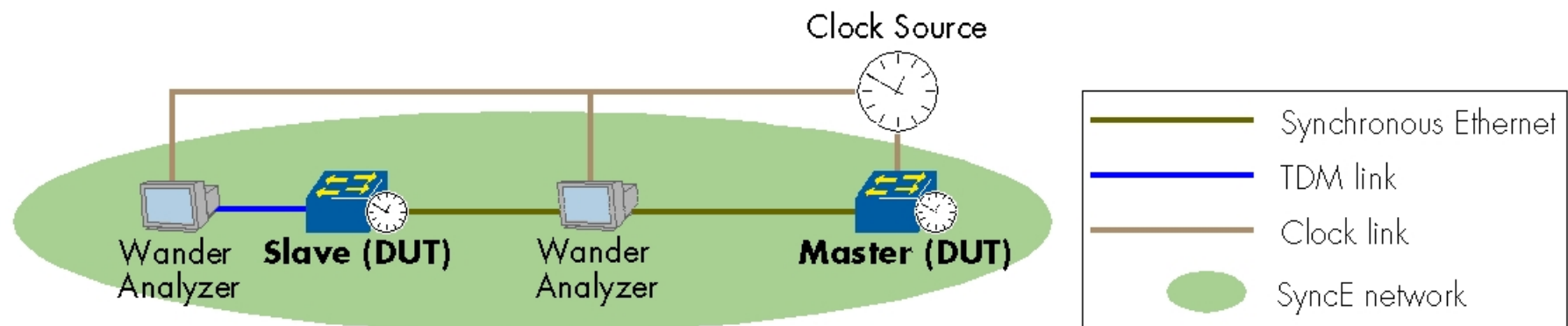

ESMC Results

Relevant to carrier deployment tested:

- Protocol Interoperability
- Reaction to Events
 - New clock selection

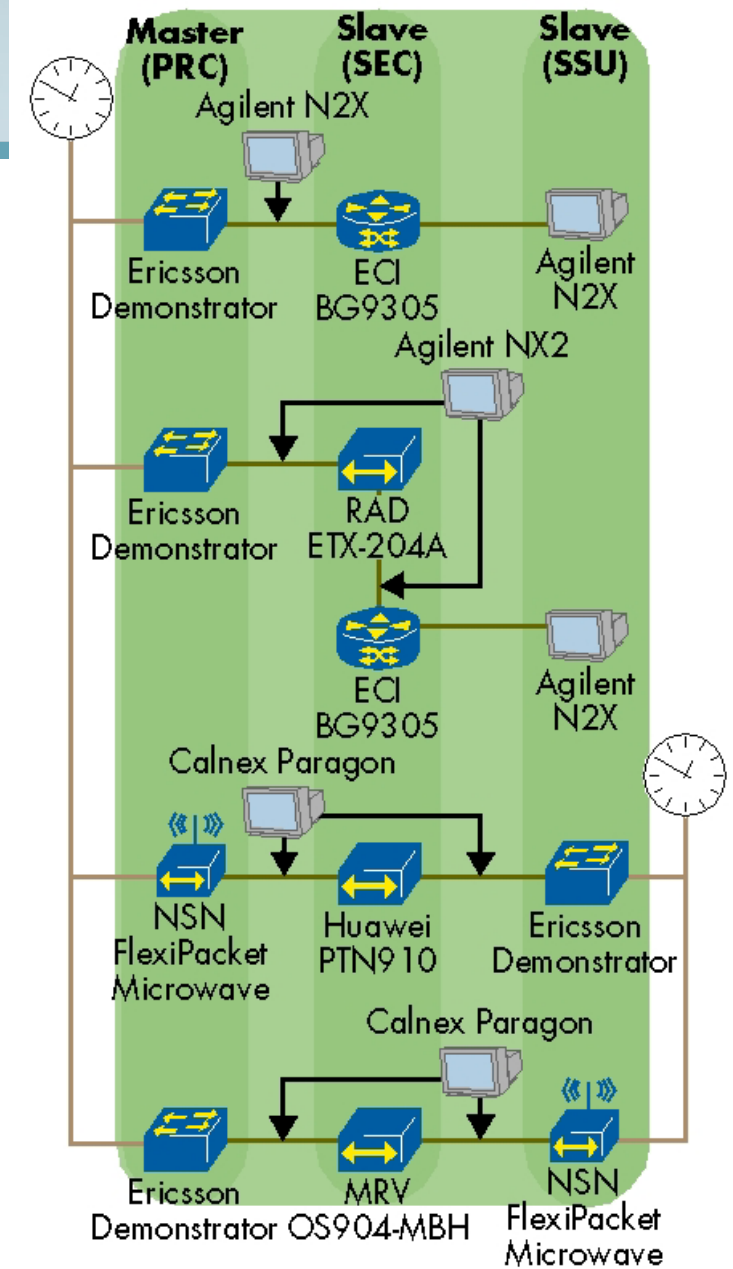

PTPv2 over Microwave

Verify Master and Slaves can Synch over Microwave

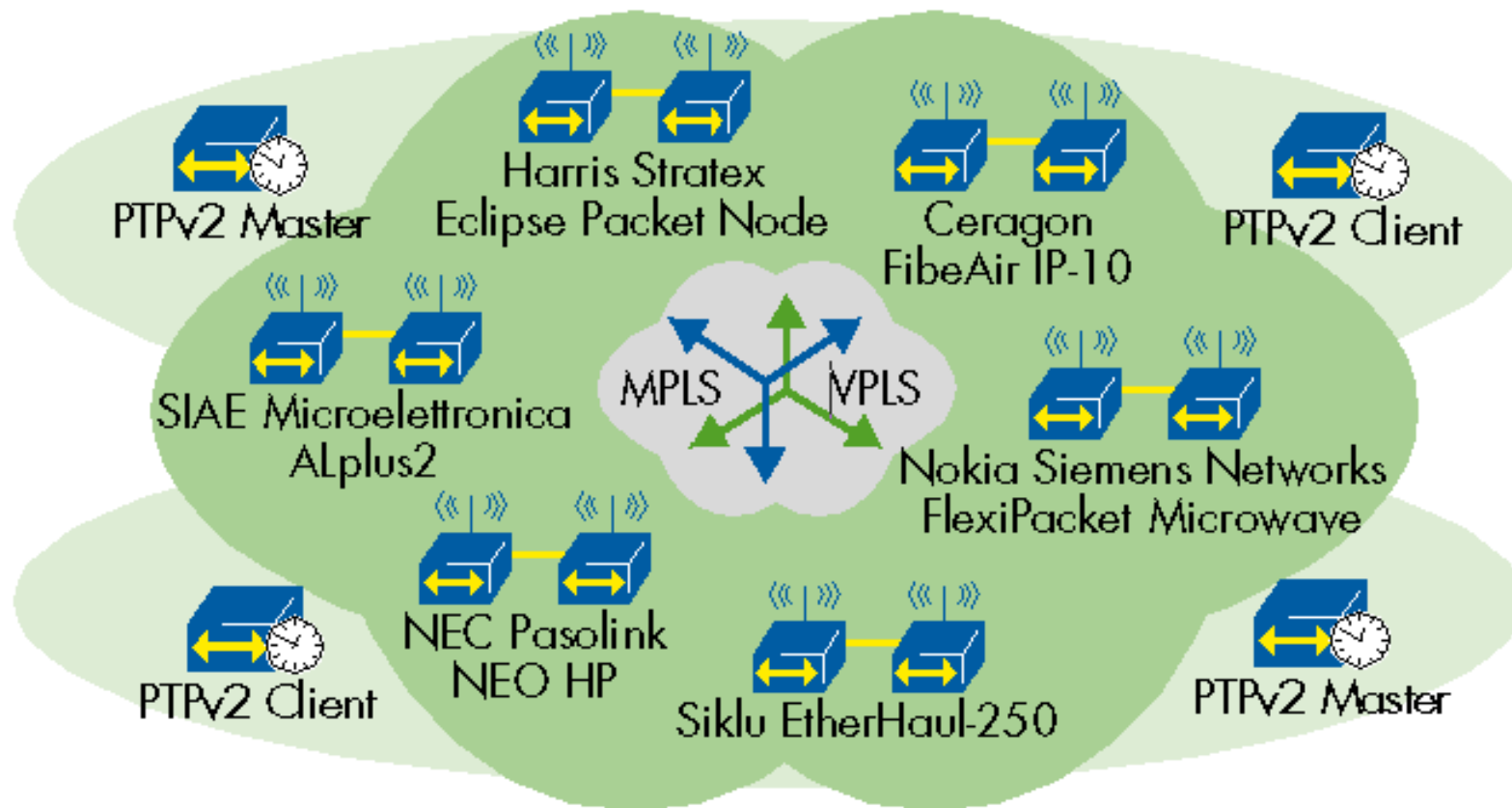

Summary

- **MEF pushing for Carrier Ethernet for Mobile Backhaul**
- **Increased protocol implementations**
- **Testing PTPv2 is:**
 - Time consuming
 - Impaired networks (even emulated) – a challenge